

# RecyClass

## HANDBOOK ON DECORATIVE TECHNOLOGIES

APPLIED ON  
LDPE & PP FLEXIBLE  
PACKAGING

DECORATION STATE-OF-THE-ART

## CONTENT

CONTENT .....	2
INTRODUCTION .....	3
1. DECORATIVE TECHNOLOGIES MAPPING.....	3
2. DECORATIVE TECHNOLOGIES DEFINITION .....	5
2.1 Direct Printing .....	5
2.1.1 Definition & formulation .....	5
2.1.2 Printing Structures.....	6
2.1.3 Printing vs Finishing.....	7
2.2 Metallisation .....	8
2.3 Transfer Technologies .....	8
2.3.1 Cold transfer .....	8
2.3.2 Hot stamping.....	9
2.4 Pressure Sensitive Labels.....	10
2.4.1 Definition & Process .....	10
2.4.2 Pressure Sensitive Adhesives .....	11
DOCUMENT VERSION HISTORY .....	12

## INTRODUCTION

This document aims to map and define all existing decorative technologies applied on LDPE and PP flexible packaging in the EU market. This terminology document targets different purposes:

- Referencing an exhaustive list of the decorative technologies applied on PE and PP flexible packaging in the EU market
- Harmonizing the wordings and definitions on decoration technologies
- Providing clear information on the structures and application processes of decoration technologies

As the present document corresponds to the current state-of-the-art, this mapping and terminology will be periodically updated following the latest developments on decoration technologies on PE and PP flexible packaging in the EU market.

Based on the exhaustive mapping, this document also enables companies to have an overview of the available decoration technologies in order to find alternatives to improve the design-for-recycling of PE and PP flexible packaging.

## 1. DECORATIVE TECHNOLOGIES MAPPING

The Decoration Taskforce participants identified four categories of decorations, as listed below, that includes all types of printing, adhesive, labelling, metallisation, and partial metallisation technologies.

The first table maps the decorative technologies applied on PE and PP flexibles and summarizes their key parameters. Detailed definition and explanation of each technology can be found in section 2.

# RecyClass

Table 1: Decorative Technologies Overview

DECORATIVE TECHNOLOGY	TECHNOLOGY SUB-CATEGORY	ADHESIVE TECHNOLOGY	COATING CHEMICAL NATURE	PRINTING INKS	RECYCLING BEHAVIOUR
<b>DIRECT PRINTING</b>	Surface Printing	No adhesive	n.a.	Common binders: NC, PVB, PVC, PU, Acrylates	Not separable
	Reverse Printing	Laminating adhesive			
<b>METALLISATION</b>	Physical vapor deposition	No adhesive	Aluminium	n.a.	Not separable
<b>TRANSFER TECHNOLOGIES</b>	Cold Transfer	Water-based (dispersion)	Polyacrylates (conventional drying or UV curing)	<i>Cf. direct printing</i>	Not separable as finishing (direct printed)
	Hot Stamping	Hotmelt	Polyacrylates, Polyamides, Polyolefins, rubber, natural polymers, and more		
<b>PRESSURE SENSITIVE LABELS</b>	-	Water-based (emulsion)	Acrylic	<i>Cf. direct printing</i>	Separable if washable or releasable adhesive
		Hotmelt	UV reactive Block-copolymer rubber		

## 2. DECORATIVE TECHNOLOGIES DEFINITION

The definitions were developed by the Decoration Taskforce participants, that include companies from the entire plastic value chain and European organisations represented by experts in field of packaging decoration. The document is indeed aligned with the European Printing Ink Association<sup>1</sup> (EuPIA), the Association of the European Adhesive & Sealant Industry<sup>2</sup> (FEICA), and the European association for the self-adhesive label industry<sup>3</sup> (FINAT), who contribute to establish a common terminology within Europe.

### 2.1 DIRECT PRINTING

#### 2.1.1 DEFINITION & FORMULATION

Printing can be applied with various **printing processes**, including flexography, gravure, silk screening, digital print, and offset. Each process can be characterized by the thickness of the deposited ink layers:

Table 2: Overview of Printing Processes used for Flexible Plastic Packaging

	PRINTING PROCESS	INK DEPOSIT THICKNESS
<b>ANALOG PRINTING</b>	Silk screen	<b>5 – 280 µm</b>
	Offset	<b>0,5 – 2 µm</b>
	Flexography	<b>1 – 8 µm</b>
	Gravure	<b>1 – 20 µm</b>
<b>DIGITAL PRINTING</b>	Inkjet	<b>1 – 3 µm</b>
	Electrophotography	<b>± 10 µm</b>

RecyClass endorsed the **definition** of EuPIA<sup>4</sup> on inks:

a. Mixtures of colourants with other substances which are applied on materials to form a graphic or decorative design together with or without.

---

<sup>1</sup> <https://www.eupia.org/>

<sup>2</sup> <https://www.feica.eu/>

<sup>3</sup> <https://www.finat.com/>

<sup>4</sup> *EuPIA definition of inks and other associated definitions can be found in the [EuPIA glossary](#).*

# RecyClass

b. Other coloured or uncoloured overprint varnishes/ coatings or primers which are normally applied in combination with a) in order to enable the printed design to achieve specific functions such as ink adhesion, rub resistance, gloss, slip/friction, durability etc.

However, the term "Printing inks" does not include coatings which are applied with the prime objective of enabling the material or article to achieve a technical function such as heat sealing, barrier, corrosion resistance etc., as opposed to a graphic effect, even though they may be coloured. These "coatings" with a purely technical function should be considered separately.

Several **types of inks** have been identified as usual for direct printing. For flexible applications, majority is currently solvent based. Usually, inks are composed of 4 different components: solvent, polymeric binder, pigments, and some additives. NC (nitrocellulose) represents 90% of the market share for binders, followed by PVB (polyvinyl butyral), PVC (polyvinyl chloride), PU (polyurethanes), and acrylates that are also commonly used as binders. Others less common examples are PA (polyamides), CAP (celluloseacetopropionat), CAB (celluloseacetobutyrat). Once applied on the packaging, inks are dried by heat removing the solvent fraction, UV-cured or electron beam-cured.

The different printing technologies are using the same type of pigments. Coloured pigments are typically organic substances of different structures (Azo, Naphtol AS, Chinacridon, Phtalocyanin, etc.). For white pigments, titanium dioxide remains the main used inorganic filler, but others such as  $\text{SiO}_2$ ,  $\text{CaCO}_3$  or  $\text{BaSO}_4$  are also used.

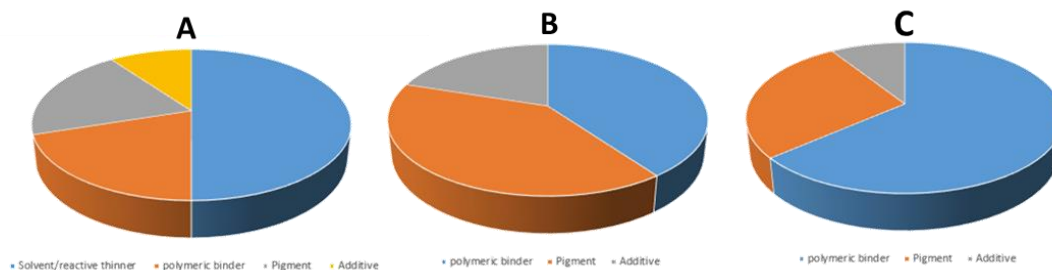

Figure 1: Composition of A) wet flexography / gravure inks, B) dried solvent or water-based inks, and C) UV- or EB-cured flexography inks

A sub-family of printing inks are **metallic inks, pearlescent inks and inks with chrome and mirror effects**. Some types of metallic inks can provide very high reflectance properties, that differ from traditional inks. These inks are typically based on PVD aluminium pigments. Synonyms of metallised inks that can be found on the market are: VMF or VMP based inks (vacuum metallised flakes or pigments). Moreover, **conductive inks** (based on silver) applied with conventional printing processes are also under development and should be investigated in the future.

## 2.1.2 PRINTING STRUCTURES

Note that printing can be present in two different kind of film structures:

- Surface printing

Surface printing refers here to a technique where the inks are printed on the outer layer of the substrate. This is principally applied on PE and coex-OPP.



Figure 2: Example of printed flexible packaging

## Surface Printing

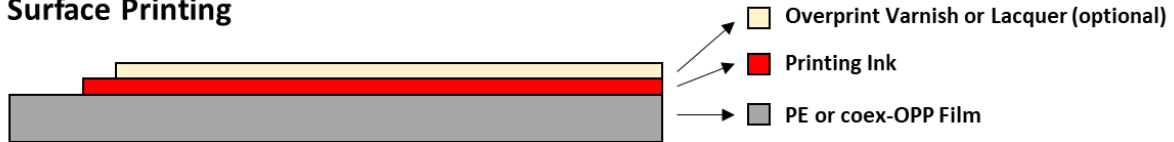

Figure 3: Schematic Representation of surface printed film structure

- Reverse Printing

Reverse printing corresponds to a technique where the ink is printed on the inner layer of a substrate and where the ink is sandwiched between two films after lamination in order to have e.g. a better scratch resistance during transportation. Reverse printed films are often MDO-PE or coex-OPP but BOPP, PET and PA play a role as well. The second web is often made of PE, CPP or BOPP. In such cases, the ink is in sandwich position between the substrate and a laminating adhesive.

## Reverse Printing

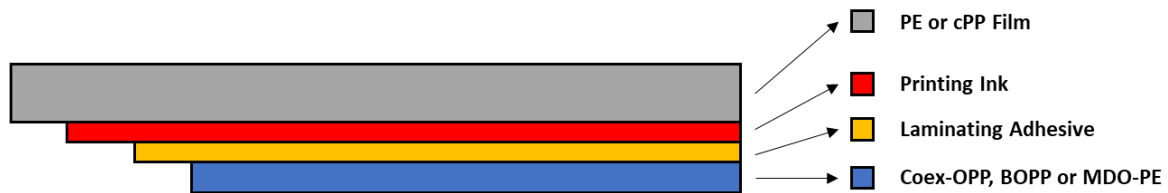

Figure 4: Schematic representation of printed film with reverse printing

## 2.1.3 PRINTING VS FINISHING

However, it is worth to consider separately printing and finishing:

- **Printing** is the process for ink deposition and includes all types of inks deposited by conventional and digital processes, as reported above.
- **Finishing** is related to additional coatings deposited on the printing and providing additional functions to the decoration (protection, visual aspect, etc.). Two types of finishing technologies can be identified:
  - Spraying or lacquering (roll-to-roll coating), that can be additional uncoloured varnish or coloured lacquer.
  - Transfer technologies, as cold foil and hot stamping (cf: transfer technologies section).



Figure 5: Example of printed plastic films

## 2.2 METALLISATION

Metallisation can be deposited via **physical vapor deposition** (or vacuum metallisation or PVD substrates). Aluminium metallization is deposited to the label substrate, representing a thin aluminium layer (between 50 and 100nm).

For most of the label industry, metallisation is incorporated by the manufacturer of the substrate prior to printing. A few printers/converters apply metallization in-house. Metallisation can be applied on paper labels as well.



Figure 6: Picture of metallised flexible packaging

## 2.3 TRANSFER TECHNOLOGIES

There are two main technologies for transfer decoration. Both are characterized by a multi-layer structure that includes metallisation as reported in the pic on the right. Apart from the carrier and release layer, all layers will be transferred to a label (the substrate) applied on the flexible packaging. As reported above, transfer decorations can be characterized as finishing technologies.

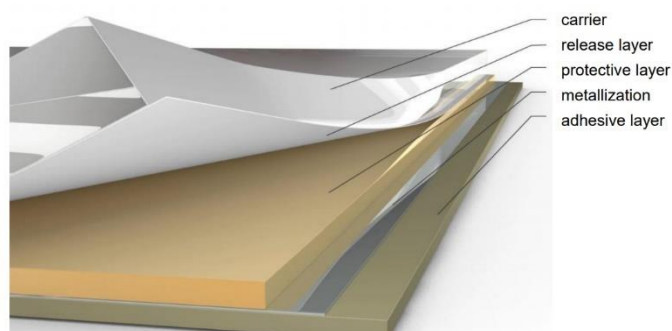

→ Total thickness of all layers 1.5 to 3 g/m<sup>2</sup> ≈ 1.5 to 3 μm

Figure 7: Common structure for transfer decoration

### 2.3.1 COLD TRANSFER

Often described as an evolution of hot stamping, cold transfer is a method of applying metallic layers onto a substrate utilizing an adhesive rather than the die utilized in hot stamping. Cold transfer can be done in two ways, and they differ based on the application methods, the transfer technique employed, and the components used (i.e., substrate, adhesive and product grades). Synonym of this technology is cold foiling, while digital metal is proprietary cold transfer technology.

Two **processes** are used to obtain the printing of the cold transfer:

- **Narrow-web flexographic** (or letterpress or offset printing): mainly used for self-adhesive labels made of plastic, generally PE or PP. Paper labels, tube laminates, IML labels and folding boxes are more and more often being finished by means of narrow-web printing as well.
- **Sheet-fed offset printing**: predominantly used to finish commercial print jobs, magazines, packaging, and wet-adhesive labels.

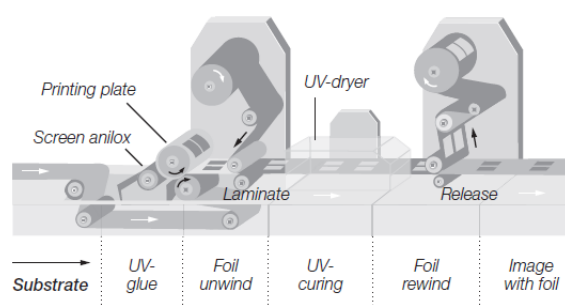

Figure 8: Representation of cold transfer process



**Analog and digital printing process** can both be used onto metallized layers via cold transfer to **print the foils**. **Types of inks** used for printing are the same as for conventional direct printing. No solvent ink can be used (“dried inks”). The **coating weight** depends on the process (cf: Printing technologies section).



Figure 9: Picture of flexible packaging decorated with cold transfer technologies

## 2.3.2 HOT STAMPING

Hot stamping is mostly used offline when embellishment is required on a pre-printed substrate. Three processes exist to apply hot stamping: Peripheral stamping, Vertical Stamping – process illustrated on the left – and Roll-on – process illustrated on the right.

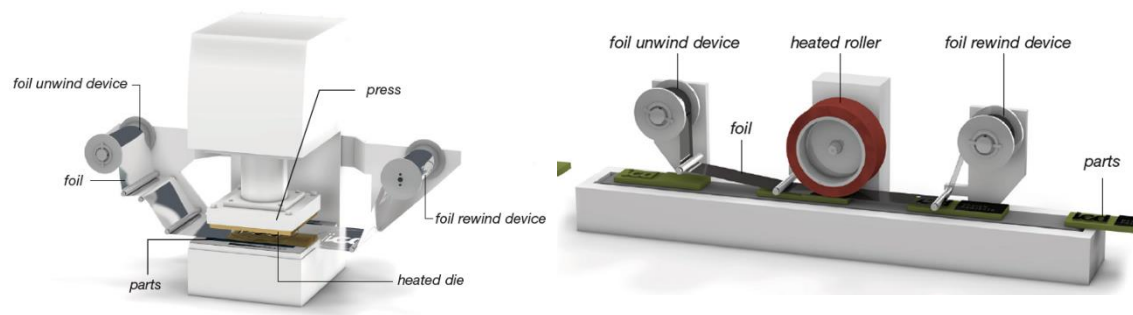

Figure 10: (left) Vertical stamping process and (right) Roll-on stamping process

Neither of the processes requires prior or subsequent treatment processes such as priming or curing. The transfer process as such is a physical operation. The optically active layers of the hot stamping product are transferred to the print substrate by means of a heated stamping die and mechanical pressure. During the transfer process, the raised surfaces of the die come into contact with the hot stamping product. In the areas of contact, layers are released from the carrier foil and simultaneously bonded to the print substrate because of the heat of the die and a defined contact pressure.

# RecyClass

The main limitation of this technology is that the types of graphics that can be applied are usually limited to text and bold images.

**Types of inks** are UV inks, conventional inks, hybrid inks. Hot stamping can be applied: under inks or over inks, under laminate coatings, under or over varnish. No solvent is used (“dried inks”), and no curing or heating is necessary.

**Coating weight** is related to the thickness of transfer finish: hot stamping approx. 2,5 g/m<sup>2</sup> (including protective, metallization and adhesive layer)



Figure 11: Picture of flexible packaging decorated with hot stamping

## 2.4 PRESSURE SENSITIVE LABELS

### 2.4.1 DEFINITION & PROCESS

Pressure Sensitive Labels (PSLs), or sometimes called self-adhesive labels, represent the most common way to apply a label on a flexible packaging.

Pressure sensitive wordings are defined by FINAT as reported below:

- **Pressure sensitive:** American term for self-adhesive (and materials).
- **Pressure sensitive label stock:** The combination of face material, pressure-sensitive adhesive and release liner from which pressure sensitive (self-adhesive) labels are manufactured.
- **Pressure sensitive laminate:** The combination of face material, pressure sensitive adhesive, and release liner used for manufacturing self-adhesive labels.
- **Pressure Sensitive Adhesive (PSA):** An adhesive which remains 'tacky' when dry and which is used in the manufacture of self-adhesive labels.

In its delivery form, PSLs have a three-layer structure:

- **Facestock:** can be either film or paper. Films are typically clear, white or metallic. Papers are typically white or metallized.
- **Pressure sensitive adhesive**
- **Liner:** is a silicon coated polyester (PET) film, glassine paper or, to a smaller extent, BOPP film. The liner is always separated during production and should not be considered in the PSL structure applied on flexibles, as it will not reach the common packaging waste streams.

It is worthwhile to also include “linerless” labels, that have the following construction: silicone release layer – print – facestock – pressure sensitive adhesive, and no liner used.

The following representation provides a schematic of PSL production:

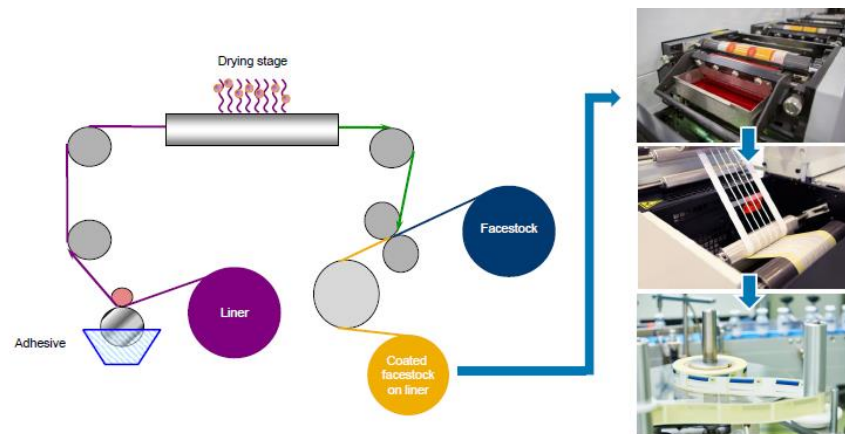

Figure 12: Schematic representation of PSL production

PSLs can be printed in many different technologies including UV, solvent, and water-based inks via gravure, flexography screen, offset or digital print processes and the print may be protected by a varnish layer or a filmic overlamine.

## 2.4.2 PRESSURE SENSITIVE ADHESIVES

Functional requirements will determine adhesive technology. The adhesives used for PSL production can be classified in 3 chemistries:

- Acrylic dispersion or emulsions
- UV reactive pressure sensitive hotmelt.
- Block-copolymer rubber PSA hotmelt

Solvent based acrylics are relatively uncommon today for label applications, as they are most commonly used in high end pressure sensitive applications such as construction and roadworks.

The coating weight of pressure sensitive adhesives could range from 10 – 25 gsm, with 12 – 17 gsm being the most common.

PSL can be designed to be permanent, removable, or washable. The behaviour of the label is strongly linked to the type of substrate (e.g., type of flexible packaging) on which the label is applied.

Additional definitions provided by FEICA are useful to define the adhesive behaviour during the recycling process and applies for all adhesive applied labels' categories listed above:

- **Water-soluble / alkali-soluble adhesive application:** Any applied adhesive capable of dissolving in water or alkali in the recycling process. The dissolved adhesive is transferred into the process water and remains in solution until the washing liquid undergoes a recovery or cleaning step.
- **Releasable adhesive application:** Any applied adhesive capable of releasing on at least one side of its bond under the specified conditions in the recycling process. After releasing, the adhesive remains on one or on both substrates. The process water does not accumulate adhesives (it is not recommended to recycle the washing solution).

## DOCUMENT VERSION HISTORY

VERSION	PUBLICATION DATE	REVISION NOTES
1.0	January 2023	Handbook on Decorative Technologies applied on LDPE & PP Flexible Packaging release

# RecyClass

c/o Plastic Recyclers Europe  
Avenue de Broqueville 12  
1150 Brussels – Belgium

Phone : +32 2 786 39 08  
info@recyclclass.eu

[www.recyclclass.eu](http://www.recyclclass.eu)